

Solar cell operating principles

1. **Absorption** of photons \Rightarrow generation of electron-hole pairs
2. **Separation** of carriers in the internal electric field created by p - n junction and **collection** at the electrodes \Rightarrow potential difference and current in the external circuit
3. Potential difference at the electrodes of a p - n junction \Rightarrow **injection** and **recombination** of carriers \Rightarrow losses

The resulting current in the external circuit: $I = I_L - I_D$ (V)

- photocurrent I_L
- dark (diode) current I_D

External parameters of a solar cell

I-V measurement

Standard test conditions:

- AM1.5 spectrum
- irradiance 1000 W/m²
- temperature 25°C

External parameters:

- **Short circuit current I_{sc} [A]**
- **Open circuit voltage V_{oc} [V]**
- **Fill factor ff**
- **Maximum (peak) power P_{max} [W_p]**
- **Efficiency η**

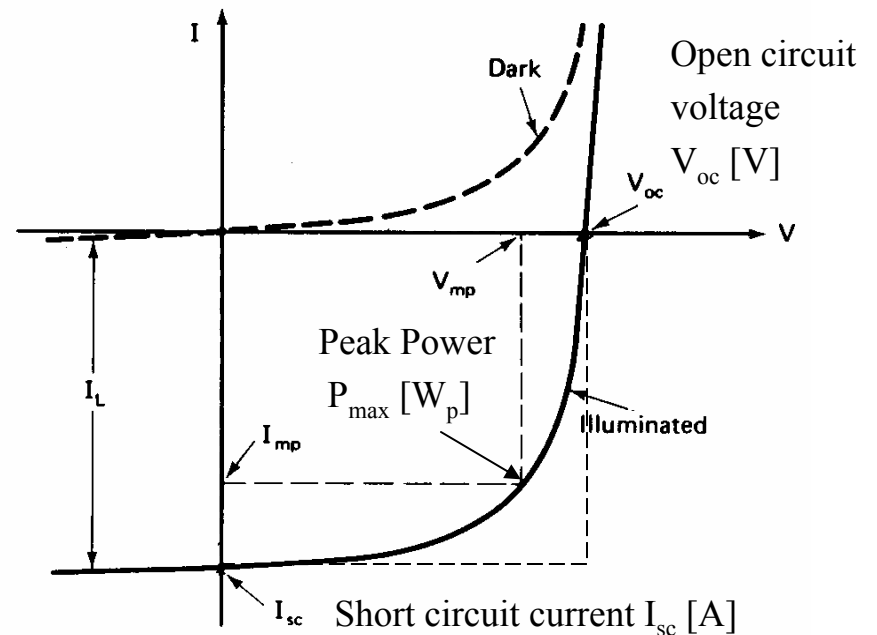

$$P_{max} = V_{mp} I_{mp} = ff V_{oc} I_{sc}$$

$$\eta = P_{max} / P_I = ff V_{oc} I_{sc} / P_I$$

Solar cell performance

Single junction solar cell:

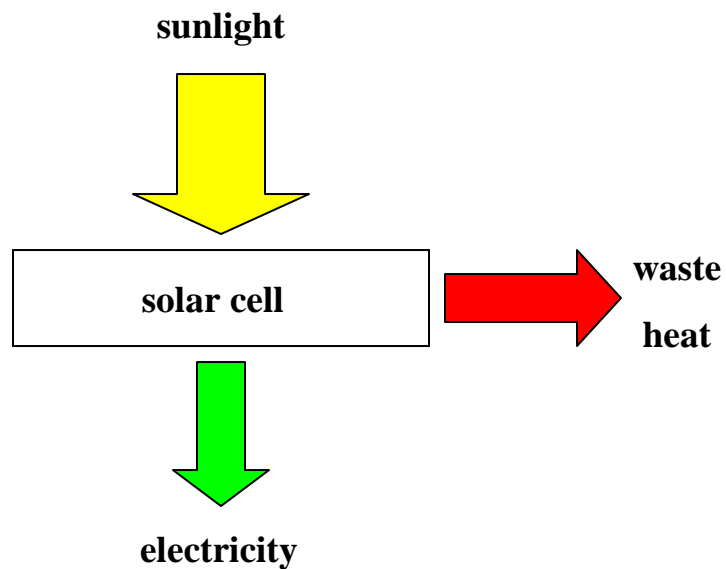

Typical commercial c-Si solar cell

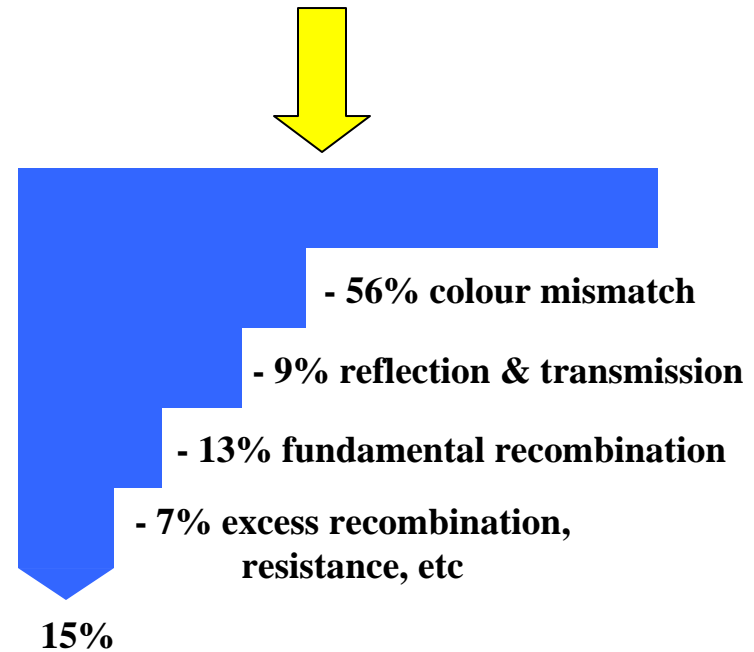

Solar cell performance

Optical losses:

Non-absorption

Thermalization

Reflection

Transmission

Area loss

Collection losses:

Recombination

- bulk

- surface

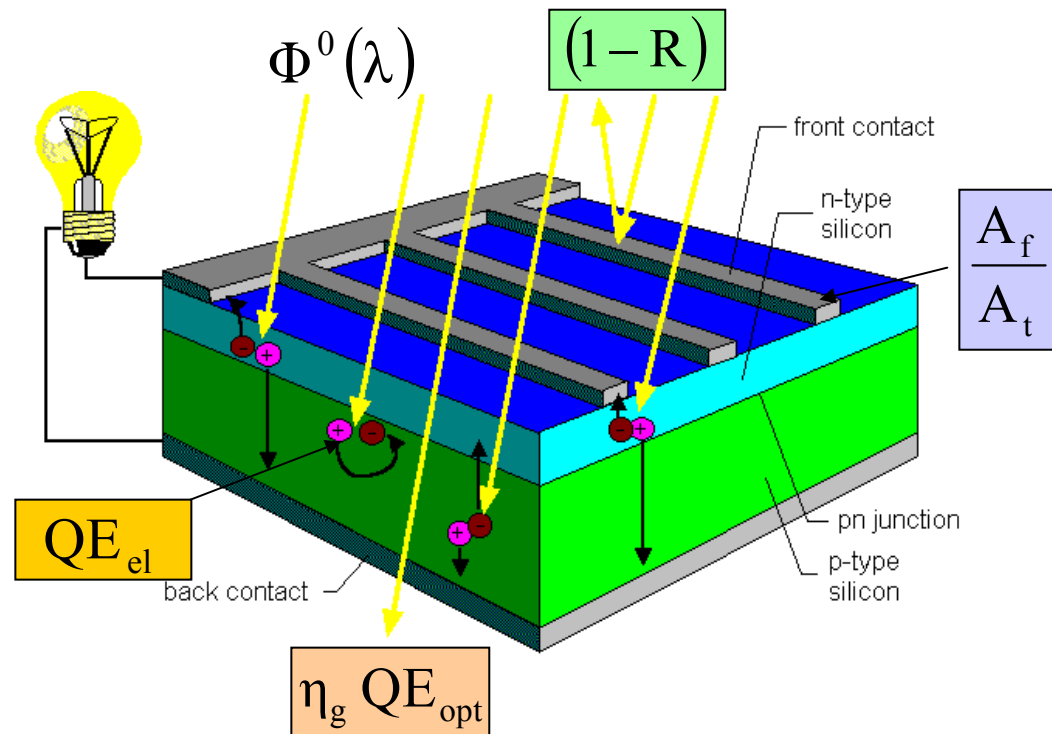

Solar cell performance

Optical losses: Non-absorption

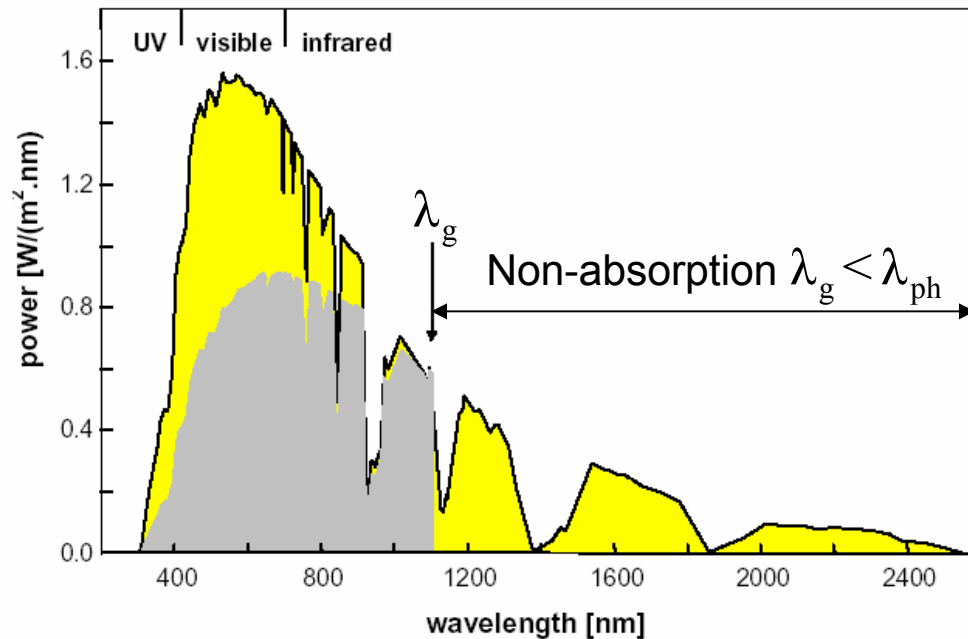

Non-absorption $E_{ph} < E_G$

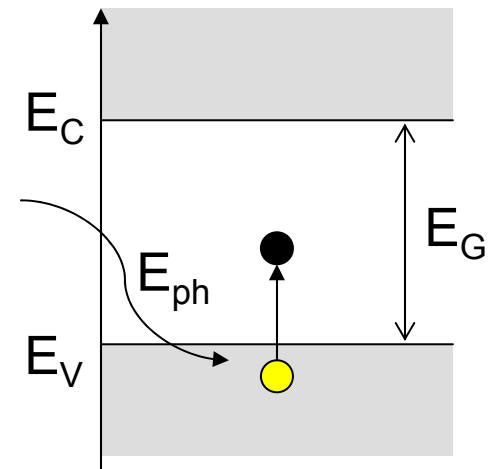

$$P_I = \int_0^{\infty} \Phi^0(\lambda) \frac{hc}{\lambda} d\lambda$$

$\Phi^0(\lambda)$ Photon flux density: number of photons per unit area per unit time and unit wavelength

$$\frac{\int_0^{\lambda_g} \Phi^0(\lambda) \frac{hc}{\lambda} d\lambda}{\int_0^{\infty} \Phi^0(\lambda) \frac{hc}{\lambda} d\lambda}$$

Solar cell performance

Optical losses: Thermalization

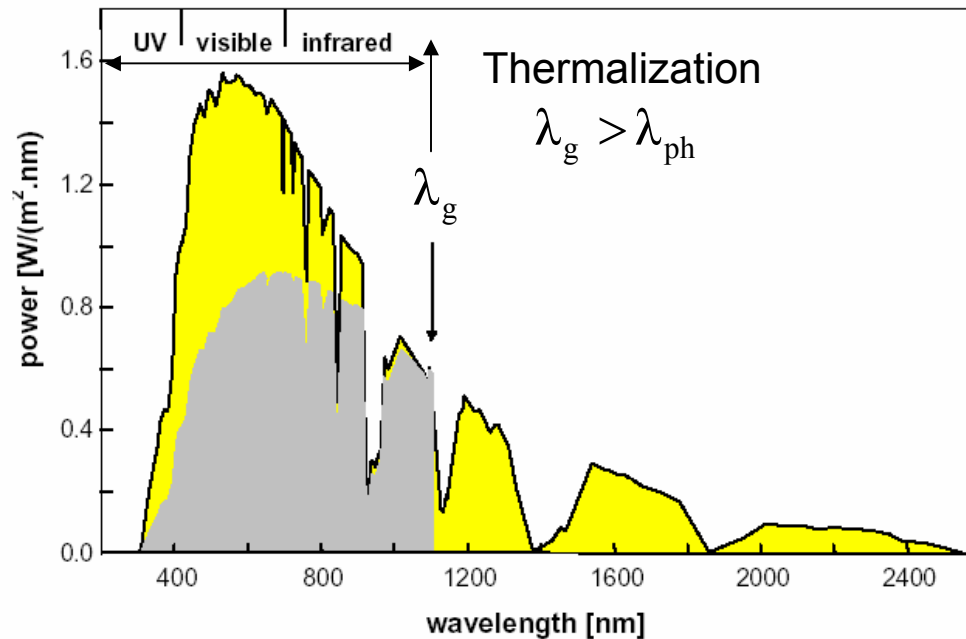

$$P_I = \int_0^{\infty} \Phi^0(\lambda) \frac{hc}{\lambda} d\lambda$$

$\Phi^0(\lambda)$ Photon flux density: number of photons per unit area per unit time and unit wavelength

Thermalization $E_{ph} > E_G$

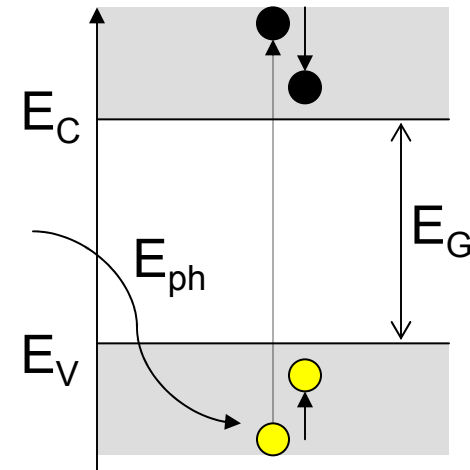

$$\frac{E_g \int_0^{\lambda_g} \Phi^0(\lambda) d\lambda}{\int_0^{\lambda_g} \Phi^0(\lambda) \frac{hc}{\lambda} d\lambda}$$

Solar cell performance limits

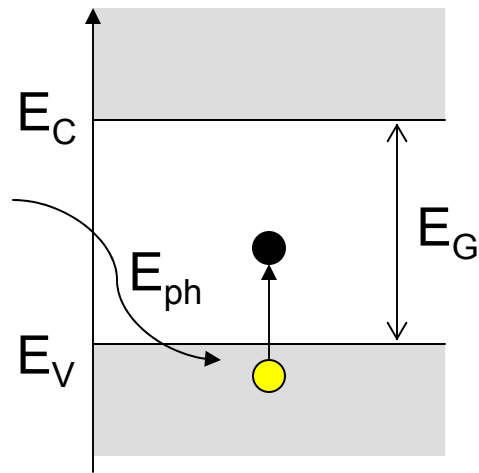

Non-absorption $E_{ph} < E_G$

$$\frac{\int_0^{\lambda_g} \Phi^0(\lambda) \frac{hc}{\lambda} d\lambda}{\int_0^{\infty} \Phi^0(\lambda) \frac{hc}{\lambda} d\lambda}$$

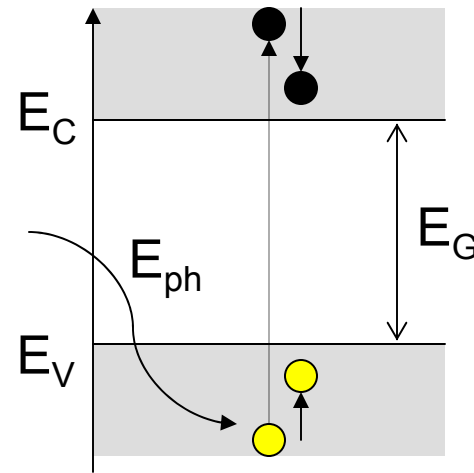

Thermalization $E_{ph} > E_G$

$$\frac{E_g \int_0^{\lambda_g} \Phi^0(\lambda) d\lambda}{\int_0^{\lambda_g} \Phi^0(\lambda) \frac{hc}{\lambda} d\lambda}$$

About 55% of solar energy is not usable by PV cells

Solar cell performance

Optical losses: Reflection and transmission

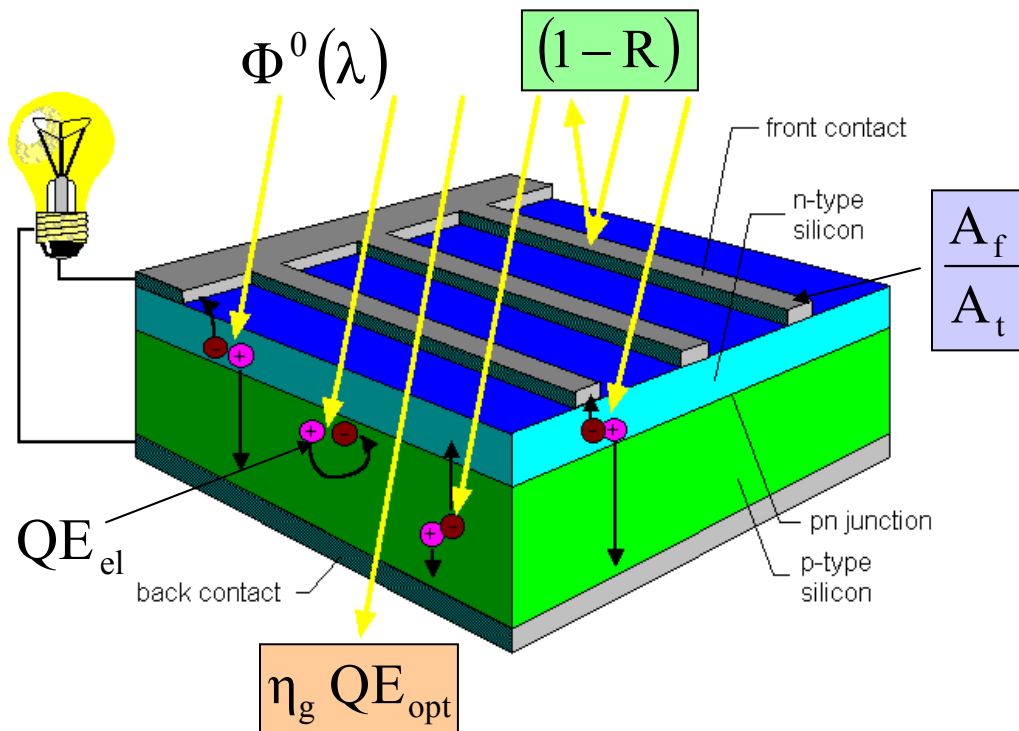

Reflection:

- Different refractive indices

Transmission:

- finite thickness of a cell
- absorption coefficient

Area loss:

- metal electrode coverage

Solar cell performance

Collection losses: Recombination

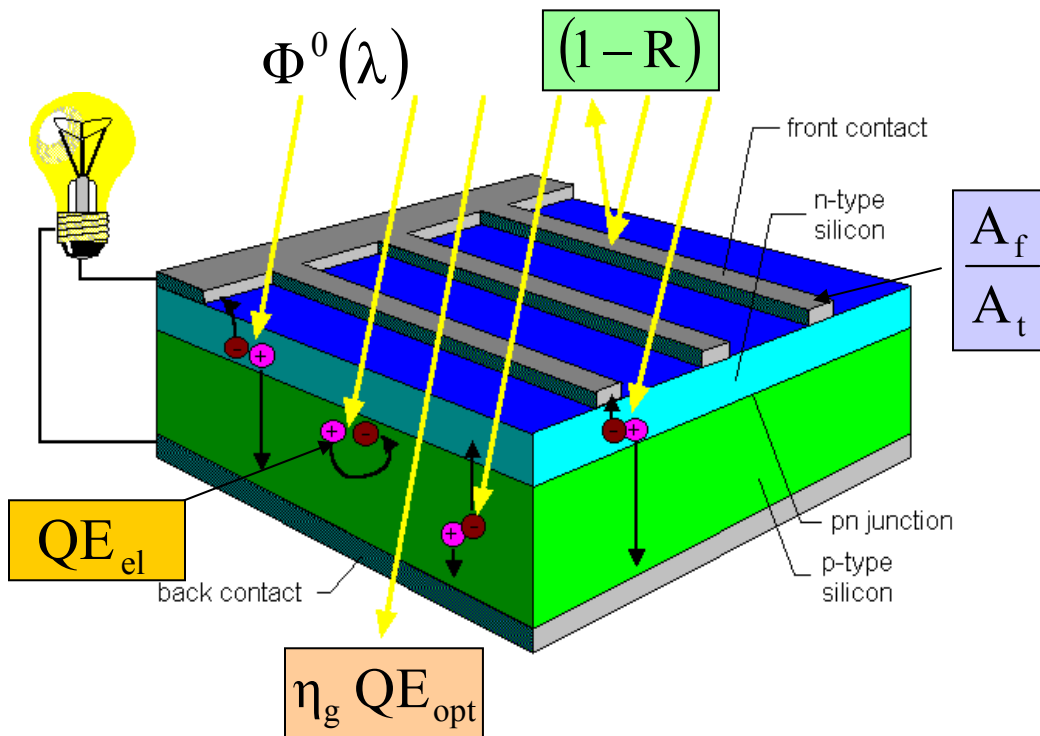

Recombination:

- bulk recombination (minority carrier lifetime)
- surface recombination (surface recombination velocity)

$$J_{\max} = q \int_0^{\lambda_g} \Phi^0(\lambda) d\lambda$$

$$J_{sc} = J_{\max} (1-R) QE_{opt} \eta_g QE_{el} \frac{A_f}{A_t}$$

Solar cell performance

Efficiency:

$$\eta = \frac{J_{sc} V_{oc} ff}{P_I}$$

$$P_I = \int_0^{\infty} \Phi^0(\lambda) \frac{hc}{\lambda} d\lambda$$

$$J_{sc} = (1-R) QE_{opt} \eta_g QE_{el} \frac{A_f}{A_t} q \int_0^{\lambda_g} \Phi^0(\lambda) d\lambda$$

$$\eta = \frac{q \int_0^{\lambda_g} \Phi^0(\lambda) d\lambda}{\int_0^{\infty} \Phi^0(\lambda) \frac{hc}{\lambda} d\lambda} (1-R) \eta_g QE_{opt} QE_{el} \frac{A_f}{A_t} V_{oc} ff$$

$$\eta = \frac{E_G \int_0^{\lambda_g} \Phi^0(\lambda) d\lambda}{\int_0^{\infty} \Phi^0(\lambda) \frac{hc}{\lambda} d\lambda} \frac{\int_0^{\lambda_g} \Phi^0(\lambda) \frac{hc}{\lambda} d\lambda}{\int_0^{\lambda_g} \Phi^0(\lambda) \frac{hc}{\lambda} d\lambda} (1-R) \eta_g QE_{opt} QE_{el} \frac{A_f}{A_t} \frac{q V_{oc} ff}{E_G}$$

Solar cell performance limits

$$\eta = \frac{\int_0^{\lambda_{\text{eg}}} \Phi^0(\lambda) \frac{hc}{\lambda} d\lambda}{\int_0^{\infty} \Phi^0(\lambda) \frac{hc}{\lambda} d\lambda} \cdot \frac{E_g \int_0^{\lambda_{\text{eg}}} \Phi^0(\lambda) d\lambda}{\int_0^{\lambda_{\text{eg}}} \Phi^0(\lambda) \frac{hc}{\lambda} d\lambda} \cdot \frac{A_f}{A_t} (1 - R) \eta_g \text{QE}_{\text{opt}} \text{QE}_{\text{el}} \left(\frac{qV_{\text{oc}}}{E_g} \right) \text{ff}$$

1. Loss by long wavelengths

2. Loss by excess energy of photons

3. Loss by metal electrode coverage

4. Loss by reflection

5. Loss by incomplete absorption due to the finite thickness

6. Loss due to recombination

7. Voltage factor

8. Fill factor

Solar cell performance

Optical losses:

Non-absorption

Thermalization

Reflection

Transmission

Area loss

Properties:

Optical gap

Optical gap

Refractive indices

Absorption coefficient

Metal grid design

Collection losses:

Recombination

- surface

- bulk

Surface recombination velocity

Minority carriers lifetime

Diffusion coefficient

Solar cell performance

Optimal design

$$\text{Total current: } I_T = I_0 \left(e^{qV/kT} - 1 \right) - I_L$$

Short circuit current (V=0):

$$I_{SC} = -I_L$$

High I_{sc} :

- **Minimize front surface reflection**
 - antireflection coatings
- **Minimize transmission losses**
 - thick absorber
- **Minimize surface recombination**
 - passivation layers
- **Minimize bulk recombination**
 - large diffusion lengths
 - high electronic quality material

Open circuit voltage (I=0):

$$V_{OC} = \frac{kT}{q} \ln \left(\frac{I_L}{I_0} + 1 \right)$$

Low I_0 :

- **High doping densities**
- **Low surface recombination velocities**
- **Large diffusion lengths**

$$I_0 = A \left(\frac{q D_n n_i^2}{L_n N_A} + \frac{q D_p n_i^2}{L_p N_D} \right)$$

Solar cell performance

Optimal thickness of the absorber layer:

Absorption versus collection:

- Thickness of the absorber layer
- Minority carrier diffusion length

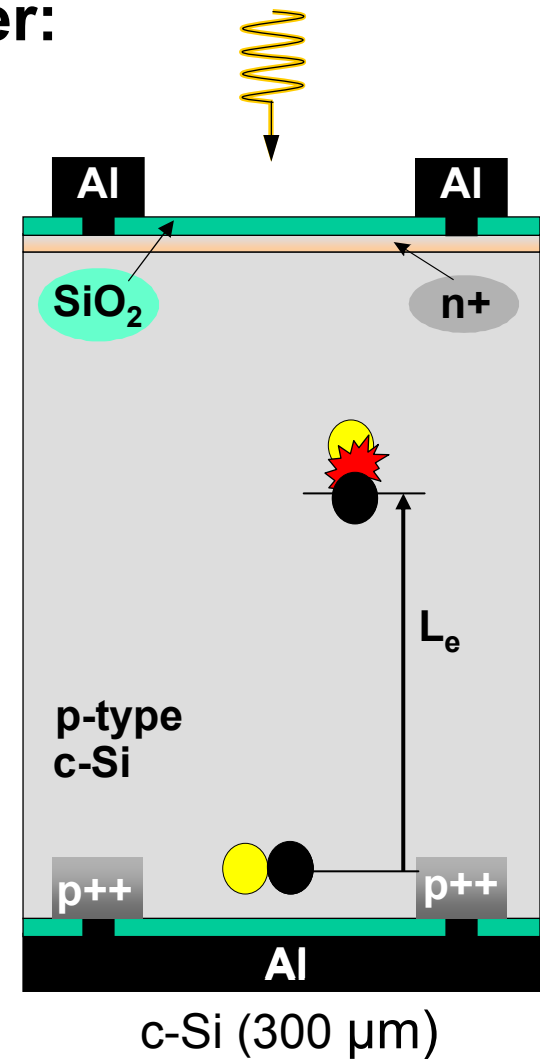

Solar cell performance

Optimal thickness of the absorber layer:

Absorption versus collection:

- Thickness of the absorber layer
- Minority carrier diffusion length

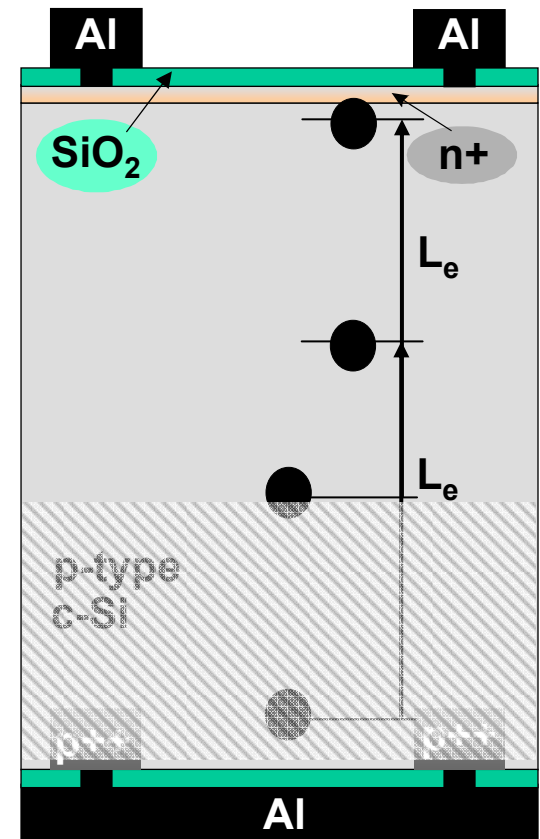

Solar cell performance

Optimal thickness of the absorber layer:

Absorption versus collection:

- Thickness of the absorber layer
- Minority carrier diffusion length

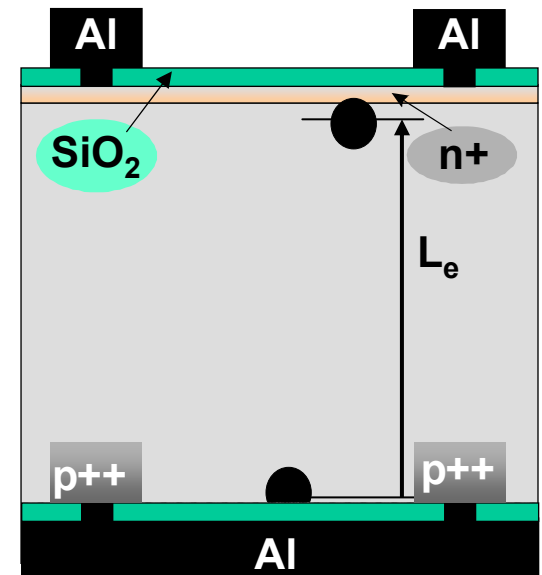

Solar cell performance

Optimal thickness of the absorber layer:

Absorption versus collection:

- Thickness of the absorber layer
- Minority carrier diffusion length

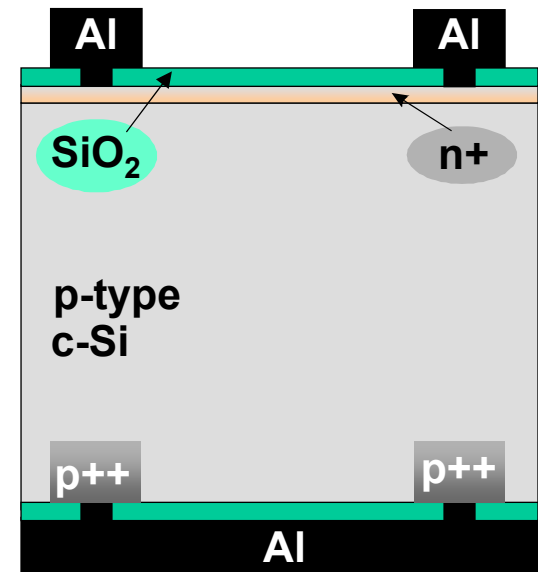

Solar cell performance

Thin absorber layer:

Increase absorption:

- Surface texture
- Antireflection coating

Avoid surface recombination:

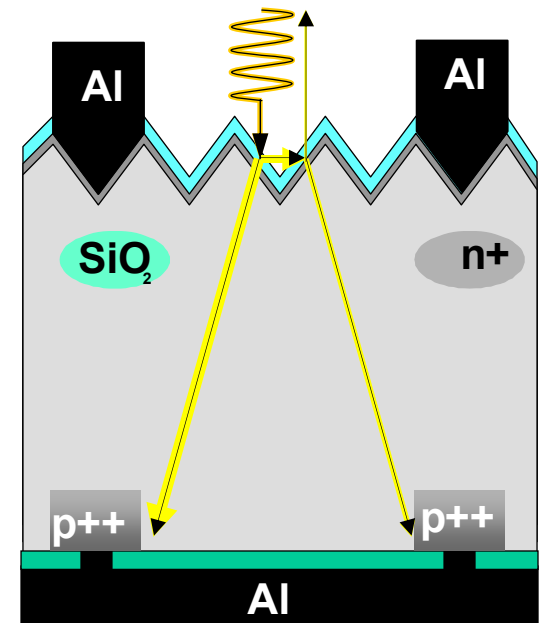

- Surface passivation

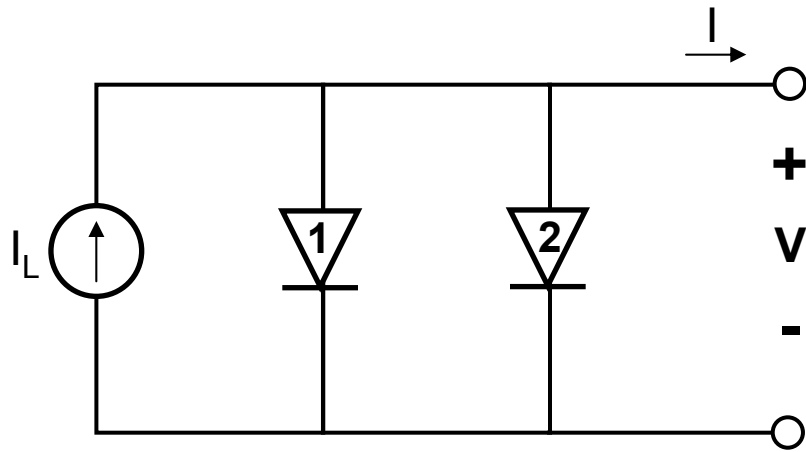

Solar cell performance

Equivalent circuit:



- current source I_L
-  diode diffusion current
-  diode recombination current

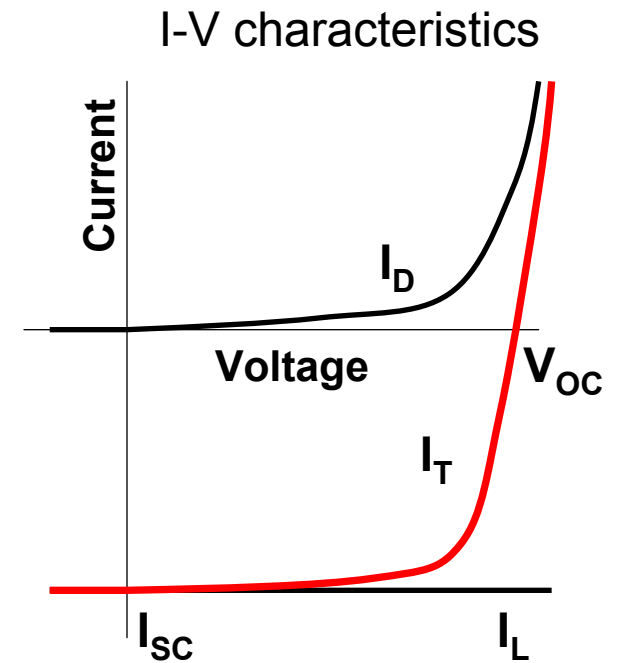

Solar cell performance

Equivalent circuit:

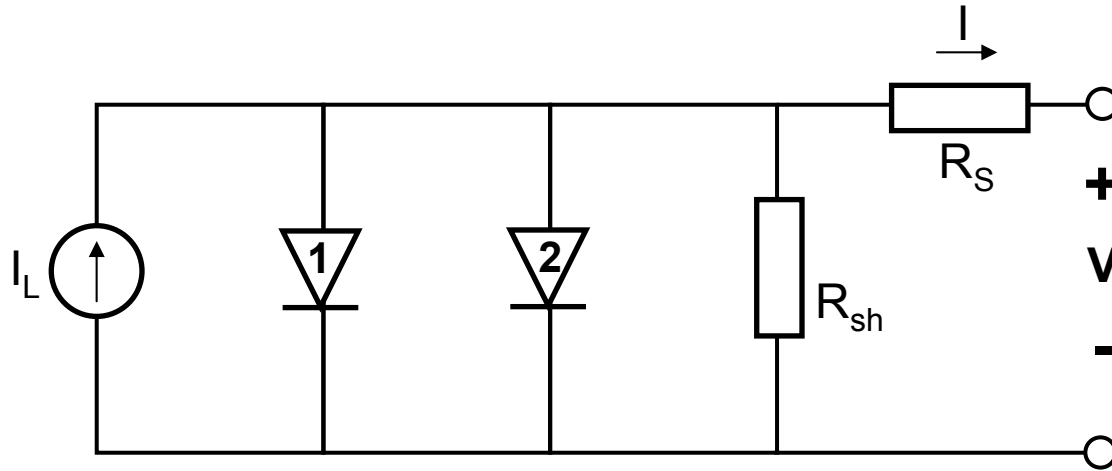

- series resistor R_s
- parallel resistor R_{sh}

Solar cell performance

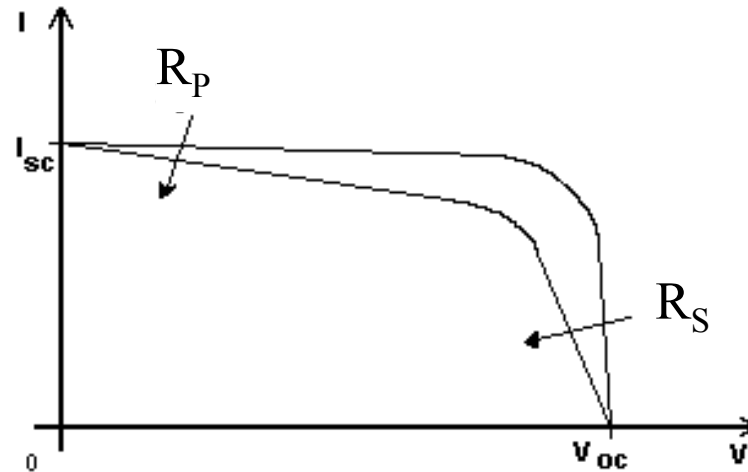

Series resistance (R_S)

- Bulk resistance of semiconductor
- Bulk resistance of metal electrodes
- Contact resistance between semiconductor and metal

Shunt (parallel) resistance (R_p)

- Leakage across the p-n junction around the edge
- Crystal defects, pinholes, impurity precipitates

Solar cell performance

Total current:

$$I_T = I_0(T) \left(e^{q(V+I_T R_S)/kT} - 1 \right) - I_L$$

Saturation current:

$$I_0 = K T^3 e^{-E_{g0}/kT}$$

Open circuit voltage:

$$V_{OC}(T) = \frac{E_{g0}}{q} - \frac{kT}{q} \ln \left(\frac{kT^3}{I_L} \right)$$

$$\frac{dV_{OC}}{dT} = -\frac{1}{T} \left[\frac{E_{g0}}{q} - V_{OC}(T) \right]$$

Si $dV_{OC}/dT = -2.3 \text{ mV}/^\circ\text{C}$

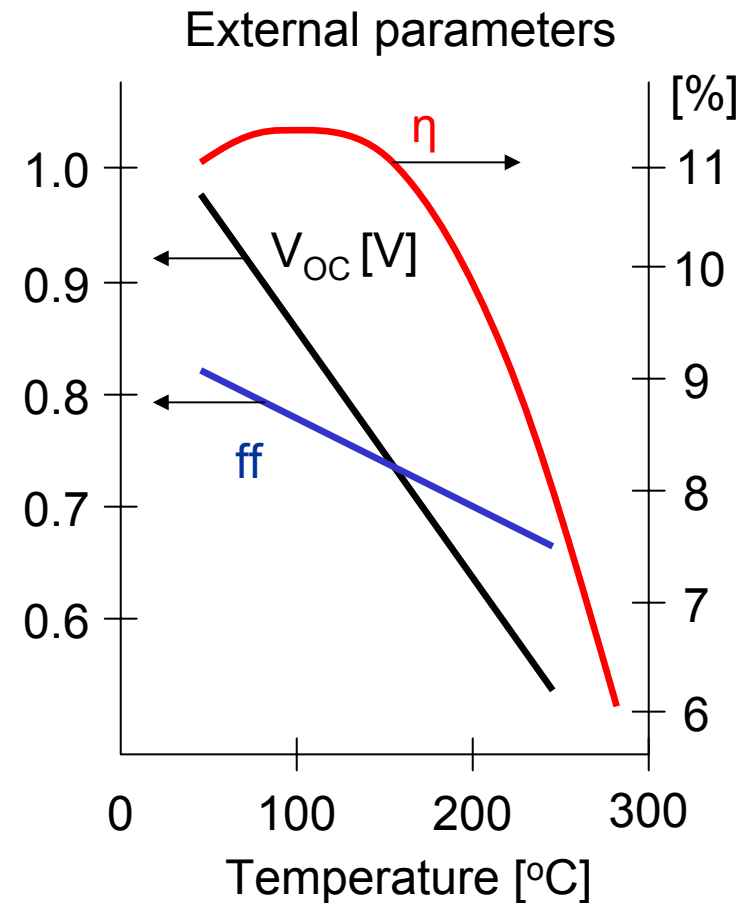

First c-Si solar cell

First c-Si solar cell

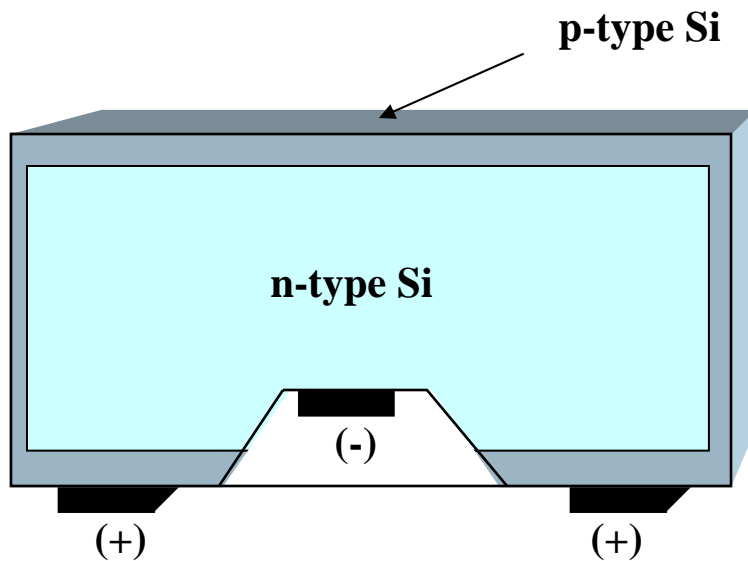

Fabricated in 1954

- wrap-around structure
- p-n junction formed by B dopant diffusion
- high resistive losses in the p-layer
- efficiency 6%

c-Si solar cell

c-Si solar cell: Efficiency improvement

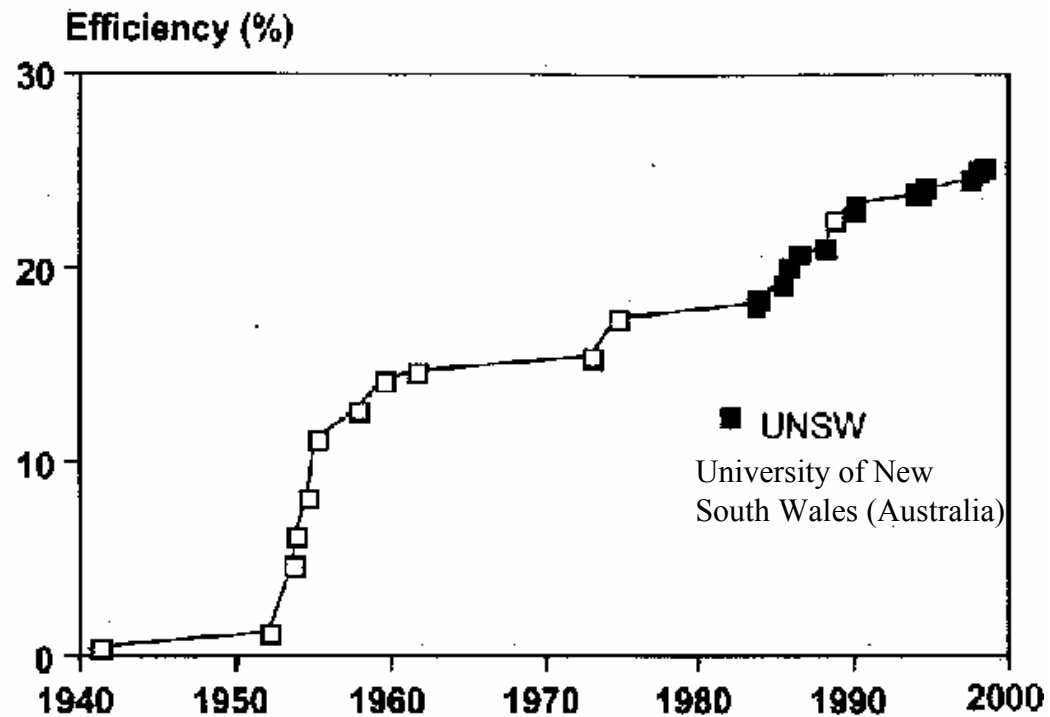

Record c-Si solar cell

c-Si solar cell: PERL structure (UNSW)

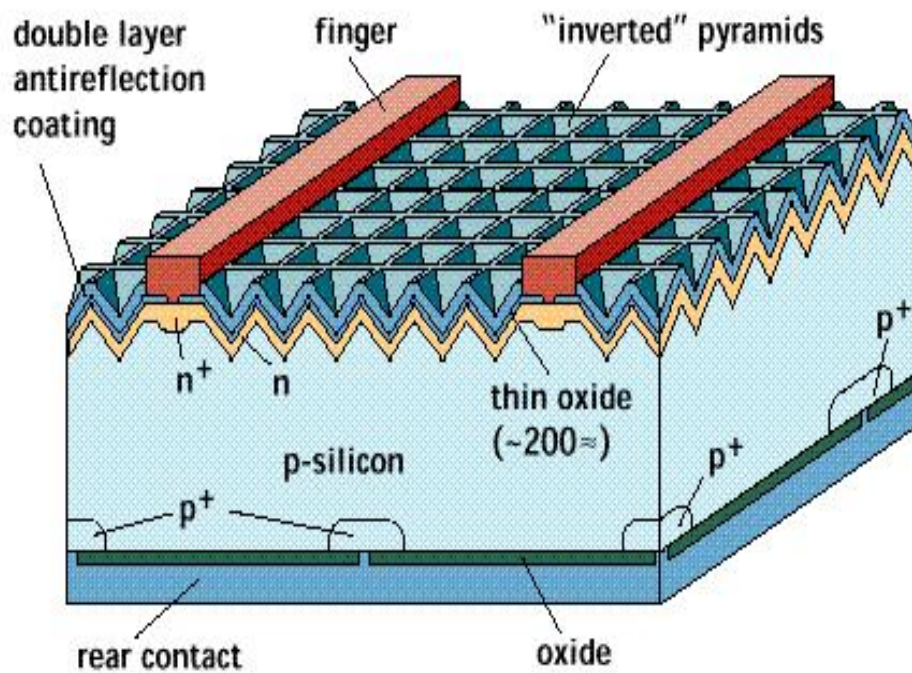

Passivated Emitter and
Rear Locally diffused

External parameters (1994):

- $J_{sc} = 40.9 \text{ mA/cm}^2$
- $V_{oc} = 0.709 \text{ V}$
- $ff = 0.827$
- $\eta = 24.0 \%$

Record c-Si solar cell

Key attributes for high efficiency solar cells:

- **Surface texture** (inverted pyramids for light trapping)
- **Selective emitter** (n^+ -layer for contact, n -layer for active part of surface)
- **Passivation of surface** (SiO_2 on both sides of solar cell)
- **Thin metal fingers on the front side**
- **Back side metalization with small contact area to the base material**
- **Locally diffused regions under contact points at the back** (BSF field)
- **Minority diffusion lengths well in excess of device thickness**